

PONAR

PRODUCT CATALOGUE

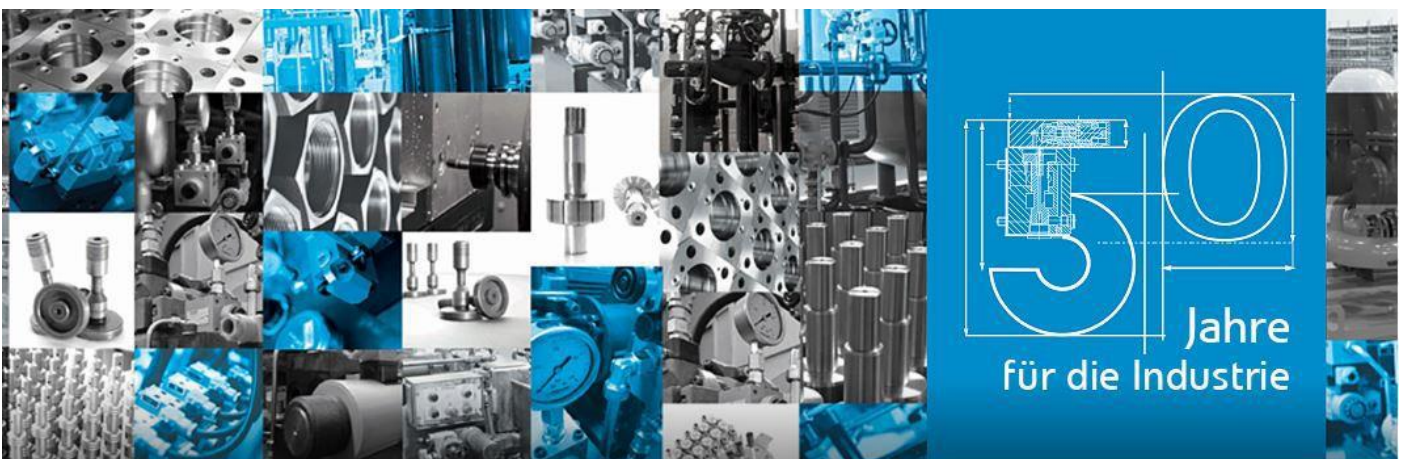

FOR

ACCESSORIES

Index

MAGRobo EVO and Accessories.....	3
FEEDERBOX.....	4
ULTRA IMPACT 3000	5
SURFACE CLEANERS.....	6
High-Pressure-Gun - Trigger Dry Shut	6
High-Pressure-Gun - Trigger Dump	6
Complete High-Pressure-Gun – Dry Shut	7
Complete High-Pressure-Gun – DumpGun	7
Foot Valves	8
Floor cleaner.....	8
CUTTING DEVICES AND SPARE PARTS	9
Cutting Devices.....	9
HOSES AND NOZZLES.....	10
PROTECTIVE EQUIPMENT.....	12

MAGRobo EVO and Accessories

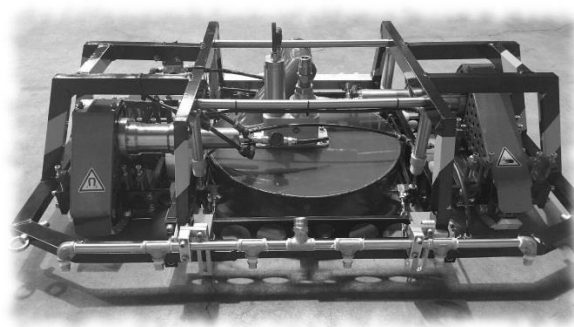

Part. number	Description
MAG-0001	<p>MAGRobo EVO</p> <p>incl. Mobile Remote-control unit</p> <p>Max. driving speed 4 m/min</p> <p>Max. working width 370 mm</p> <p>25m pneumatic hoses</p> <p><u>Water tool:</u></p> <p>Max. Pressure: 3000bar</p> <p>Max. flow rate: 45 l/min</p>
PFA-0001	<p>PN-FALL-ARRESTER-UNIT</p> <p>2 complete pneumatically driven fall arrester units incl. Mobile Remote-control unit.</p> <p>PN-FALL-ARRESTER-UNITS are equipped with air motors, pneumatic hoses, pulleys, 60m wire and also 4 magnets to secure the arrester-unit.</p>
PNS-0001	<p>PN-SUCTION-UNIT</p> <p>Pneumatic Injector suction-unit made of stainless steel</p> <p><u>Technical data:</u></p> <p>Flow rate: approx. 16.000l/min at 6 bar</p> <p>Supply rate compressed air: 3.000l/min at 6 bar <i>(Compressor is not part of delivery!)</i></p>

FEEDERBOX

Part. number	Description	
FEB-0001	<p>FEEDERbox – Automatic single flex-lance feeder</p> <p>Set including: FEEDERbox unit with air motor, front guiding pipe, rear flexible guiding hose, complete air treatment station with air hose 5 m, shoulder strap, box with additional accessories for various diameters:</p> <p>Hose catchers [mm]: 8,5/10/12/13/14/15</p> <p>End stops [mm]: 8/9,5/11,5/12,6/13,3/14,6</p> <p>Front cones [mm]: 12/14/18/20/23</p> <p>Spare drive belt and allen keys</p> <p>All is packed in dedicated safety transportation case</p>	
FEB-0003	<p>FEEDERcombo x3 in 1</p> <p>Set including: 1 x assembled FEEDERcombo x3 in 1 unit with air motor in alu skid trolley, 3x Teflon flexible front guiding hose, 3x rear flexible guiding hose, 3x box with additional accessories for various diameters:</p> <p>3 x hose catchers [mm]: 8,5/10/12/13/14/15</p> <p>3x end stops [mm]: 8/9,5/11,5/12,6/13,3/14,6</p> <p>3x spare drive belt</p> <p>1x tools set</p> <p>1x dedicated air treatment station</p>	
FEB-0004	<p>FRAME STD + CONTROL PANEL</p> <p>Set including: 1x complete pneumatic frame with 2 air motors, air hoses set, 1x special top bracket for shell flange, 1x positioning guiding box, 1x remote control panel with integrated UHP safety button, 1x dedicated air treatment station.</p> <p>Working area is 1500 x 1500 [mm].</p>	



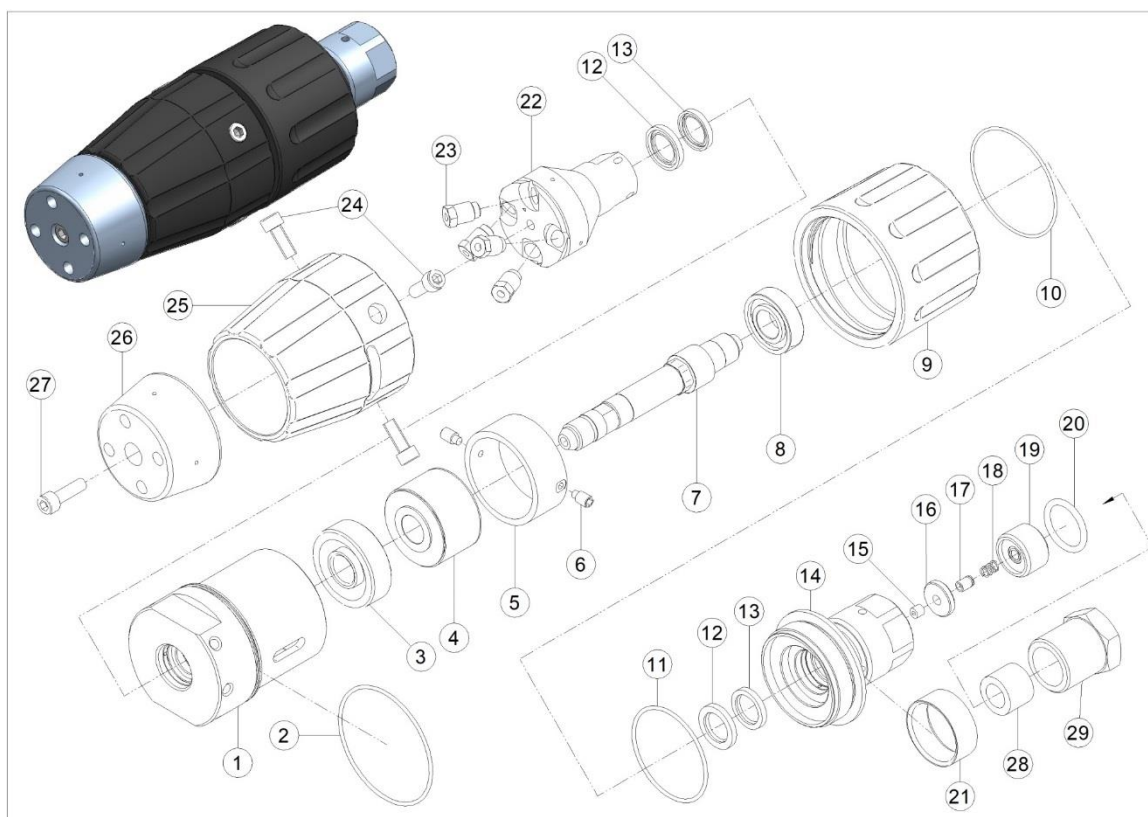

ULTRA IMPACT 3000

Part. number	Description	
<p>PDJ-0000</p>	<p>ULTRA-IMPACT 3000</p> <p>One product for all needs</p> <p>Light weight with advanced protection cover</p> <p>Magnetic brake allows easy adjustment</p> <p>Cost efficient due to long-life components</p> <p>Easy to maintain</p> <p>Universal connection kit M14 LH and 9/16" UNF LH to fit any lance in the market</p> <p>Max. Pressure: 3000 bar</p> <p>Max. Flow Rate: 28 l/min</p>	





SURFACE CLEANERS



High-Pressure-Gun - Trigger Dry Shut

Part number	Description	Connection	
PDJ-0001	Trigger Dry Shut 310 bar	M22x1,5; M24x1,5 and more	
PDJ-0002	Trigger Dry Shut 500 bar	M22x1,5; M24x1,5 and more	
PDJ-0003	Trigger Dry Shut 560 bar	M22x1,5; M24x1,5 and more	
PDJ-0004	Trigger Dry Shut 1000 bar	M22x1,5; M24x1,5 ; 9/16 UNF ; M14x1,5 and more	





High-Pressure-Gun - Trigger Dump

Part number	Description	Connection	
PDJ-0005	Trigger Dump 1000 bar	M22x1,5; M24x1,5; 9/16 UNF; M14x1,5 and more	
PDJ-0006	Trigger Dump 1400 bar	M22x1,5; M24x1,5; 9/16 UNF; M14x1,5 and more	
PDJ-0007	Trigger Dump 2500 bar	M22x1,5; M24x1,5; 9/16 UNF; M14x1,5 and more	

Complete High-Pressure-Gun – Dry Shut

Part number	Description	Connection	
PDJ-0008	Dry Shut gun 560bar, 900mm lance	M22x1,5; M24x1,5; 9/16 UNF; M14x1,5 and more	
PDJ-0009	Dry Shut gun 560bar, 450mm lance	M22x1,5; M24x1,5; 9/16 UNF; M14x1,5 and more	
PDJ-0010	Dry Shut gun 700bar, 920mm lance	M22x1,5; M24x1,5 ; 9/16 UNF; M14x1,5 and more	
PDJ-0011	Dry Shut gun 1000bar, 920mm lance	M22x1,5; M24x1,5; 9/16 UNF; M14x1,5 and more	

Complete High-Pressure-Gun – DumpGun

Part number	Description	Connection	
PDJ-0012	DumpGun 700bar, 920mm lance	M22x1,5; M24x1,5; 9/16 UNF; M14x1,5 and more	
PDJ-0013	DumpGun 1.000bar, 920mm lance	M22x1,5; M24x1,5; 9/16 UNF; M14x1,5 and more	
PDJ-0014	Under Water DumpGun 1.000bar, 920mm lance	M22x1,5; M24x1,5; 9/16 UNF; M14x1,5 and more	
PDJ-0015	DumpGun 2.800bar, 920mm lance	M22x1,5; M24x1,5; 9/16 UNF; M14x1,5 and more	

Foot Valves



Part number	Description	
PDJ-0060	Dump foot valve 1.000bar	
PDJ-0061	Dump foot valve 1.380bar	
PDJ-0062	Foot valve dry shut 1.000bar	
PDJ-0063	Dump Foot valve 2.800bar	

Floor cleaner



Part number	Description	
PDJ-0026	Floor cleaner Single 1.380 bar	
PDJ-0027	Floor cleaner Single 2.800 bar	
PDJ-0070	Floor cleaner Double 1.380 bar	
PDJ-0071	Floor cleaner Double 2.800 bar	

CUTTING DEVICES AND SPARE PARTS

Cutting Devices

Part number	Description	
PDJ-0064	Head of cutting device	
PDJ-0065	Hopper with control panel	
PDJ-0066	Power Head (Slow), pneumatically	
PDJ-0067	Cutting track (linear, approx. 2,5m long)	
PDJ-0068	Cutting nozzle 2,4mm	
PDJ-0069	Cutting nozzle 3,2mm	

HOSES AND NOZZLES

Part number	Description	
PSD-0001	Hose DN12 20m 750bar 2x M22X1,5	
PSD-0007	Hose DN12 40m 750bar 2x M22X1,5	
PSD-0014	Tube cleaning hose DN5 20m 1.000bar G1/8-M24x1,5	
PSD-0005	Tube cleaning hose DN6 15m 1.100bar G1/4-M24x1,5	
PSD-0015	Tube cleaning hose DN6 20m 1.100bar G1/4-M24x1,5	
PSD-0009	Hose DN12 20m 1.100bar M24x1,5	
PSD-0002	Tube cleaning hose DN4 12m 1.200bar M7-M24x1,5	
PSD-0008	Tube cleaning hose DN4 15m 1.200bar M7-M24x1,5	
PSD-0017	Tube cleaning hose DN8 15m 1.500bar G1/4-M24x1,5	
PSD-0016	Tube cleaning hose DN6 15m 1.640bar G1/4-M24x1,5	
<p><i>Other hoses are available on request.</i></p>		

Part number	Description	
PSD-0020x	Round jet Nozzle Form 4 for max. 1.500bar With different diameters	
PSD-0021x	Flat jet Nozzle Form 19 for max. 1.500bar With different diameters	
PSD-0022x	Round jet Nozzle Form 1 for max. 3.000bar With different diameters	
PSD-0023x	Flat jet nozzle Form 8 for max. 3.000bar With different diameters	
PSD-0024x	Round jet nozzle Sapphire for max. 3000 M10	
PSD-0025x	Whirl jet nozzles Radial up to 2.800bar With different diameters and connections	
PSD-0026x	Whirl jet nozzles Radial and front up to 2.800bar With different diameters and connections	
<p><i>Other nozzles Other nozzles are available on request.</i></p>		

PROTECTIVE EQUIPMENT

Part number	Description	
PPR-0001	Sigma Complete Kit 1000 / 2800 Sizes: S – 3XL	
PPR-0002	Sigma Complete Kit 2000 / 3000 Sizes: S – 3XL	
PPR-0003	Delta Complete Kit 1000 / 2800 Sizes: S – 3XL	
PPR-0004	Delta Complete Kit 2000 / 3000 Sizes: S – 3XL	
PPR-0005	Gamma Complete Kit 1000 / 2800 Sizes: S – 3XL	
PPR-0006	Gamma Complete Kit 2000 / 3000 Sizes: S – 3XL	
PPR-0007	Apron 1000 / 2800	
PPR-0008	Apron 2000 / 3000	
PPR-0009	Boots 3000 Sizes: 42 – 48	
PPR-0010	Gaiters 1000 / 2800	
PPR-0011	Gaiters 2000 / 3000	
PPR-0012x	Hose protections for different diameters with different length	
<i>Other protective equipment available on request.</i>		